

# AKWA+FLEX-50

## Tunable White SPECIFICATION SHEET

Project Name: .....

Specifier: .....

Location: .....

Product Code: .....

- Material:**  
Silicone
- Impact Rating:**  
IK08
- Weatherproof Rating:**  
IP68  
Wet Location
- Operating Temp:**  
-40°F - 131°F
- Bending Direction:**  
Horizontal
- UL Listed**
- Beam Angle:**  
120°
- Dimmable:**  
0-10V, DMX
- Bend Diameter:**  
>3.14"
- CRI:**  
>80+

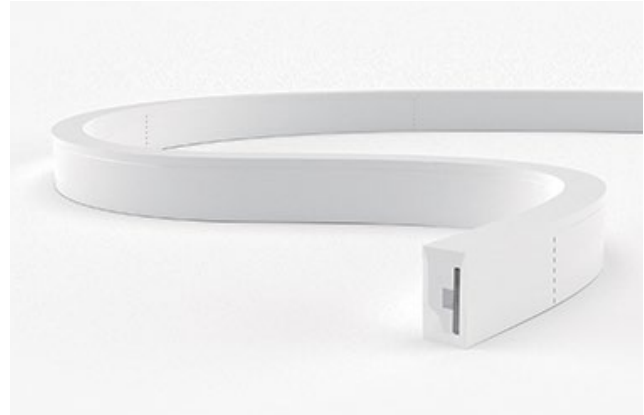

	AKWA Silicone Resin Encapsulation   Horizontal Bend
Input Voltage	24V
Power Consumption	3.7W/ft
Standard CRI	>80
LEDs per foot/m	36   120
Incremental length in/mm	3.93"   100mm

<b>Color Temperature [K]</b>	<b>Lumen Output [lm/ft]</b>
2200K - 5700K	
2200K	44lm
5700K	90lm

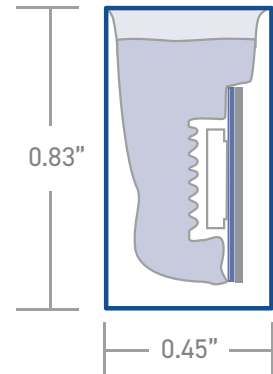

<b>Luminaire Options</b>	Mono, RGB/W & Dim to warm available - refer to specific datasheets
Control	0-10V · DMX
Optics	opal symmetrical 120° diffuser
Finish	white
Mounting	surface · wall
Accessories	mounting channel / profile

Due to tolerances of the production process and the electrical components, values for light output, color temperature and electrical power can vary up to 10%.

### How to specify KLIK USA AKWA Flex 50. Example of specification: AF50TUNXX.XBBADIM

Fixture Type	Color Temp [K]	Nominal Length [feet] with one feed <sup>1,2</sup>	Power Entry Location <sup>3</sup>	Nominal Power Entry Termination	Mounting Profiles & Brackets	Accessories	Control
AF50	TUN 2200-5700K	XX.X Specify run Length [ft]	<b>B</b> Back one end <b>B2</b> Back each end <b>E</b> End Plate one end <b>E2</b> End Plate each end <b>SL</b> Side - Left <b>SR</b> Side- Right <b>SLR</b> Side - Left+Right	<b>B</b> Bare cable with anti-wick ferrule [Std] <b>M</b> Male IP68 Connector <b>F</b> Female IP68 Connector	<b>A</b> AF50S01 <b>B</b> AF50S04 <b>C</b> AF50H05 <b>D</b> AF50V01 <b>E</b> AFPC50S01-T <b>F</b> AFSSC50FLX <b>G</b> AFSSC50S01-05 <b>H</b> AFSSC50S02-100 <b>I</b> AF50S01FLX <b>J</b> AF50S04FLX	- Profile [Std] <b>A</b> AF50ADJ	<b>DIM</b> 0-10V Dim [Std] <b>DMX1</b> DMX 1 Ch

1. Specify length of run  
 2. Max run length per power entry feed is 22' [6.7m] and 44' [13.4m] for 2 x feeds [one at each end]  
 3. B2, E2 & SLR only required if exceeding the maximum single power entry as indicated above, thus requiring TWO power entries.

# AKWA+FLEX-50

## POWER ENTRY LOCATIONS



**B**

Power entry from the BACK of the fixture [one end]

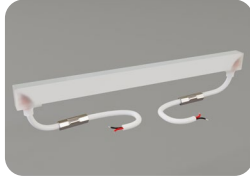

**B2**

Power entry from the BACK of the fixture [both ends] [for fixture length >22']

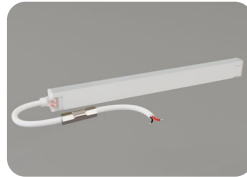

**E**

Power entry from the END of the fixture [one end]

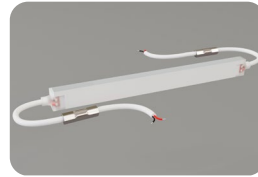

**E2**

Power entry from the END of the fixture [both ends] [for fixture length >22']

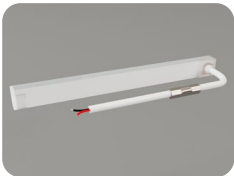

**SL**

Power entry from the SIDE of the fixture [LHS]



**SR**

Power entry from the SIDE of the fixture [RHS]

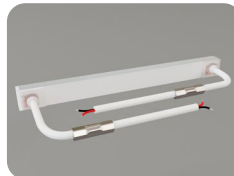

**SLR**

Power entry from the SIDE of the fixture [both L&R] [for fixture length >22']

## POWER ENTRY ORIENTATION

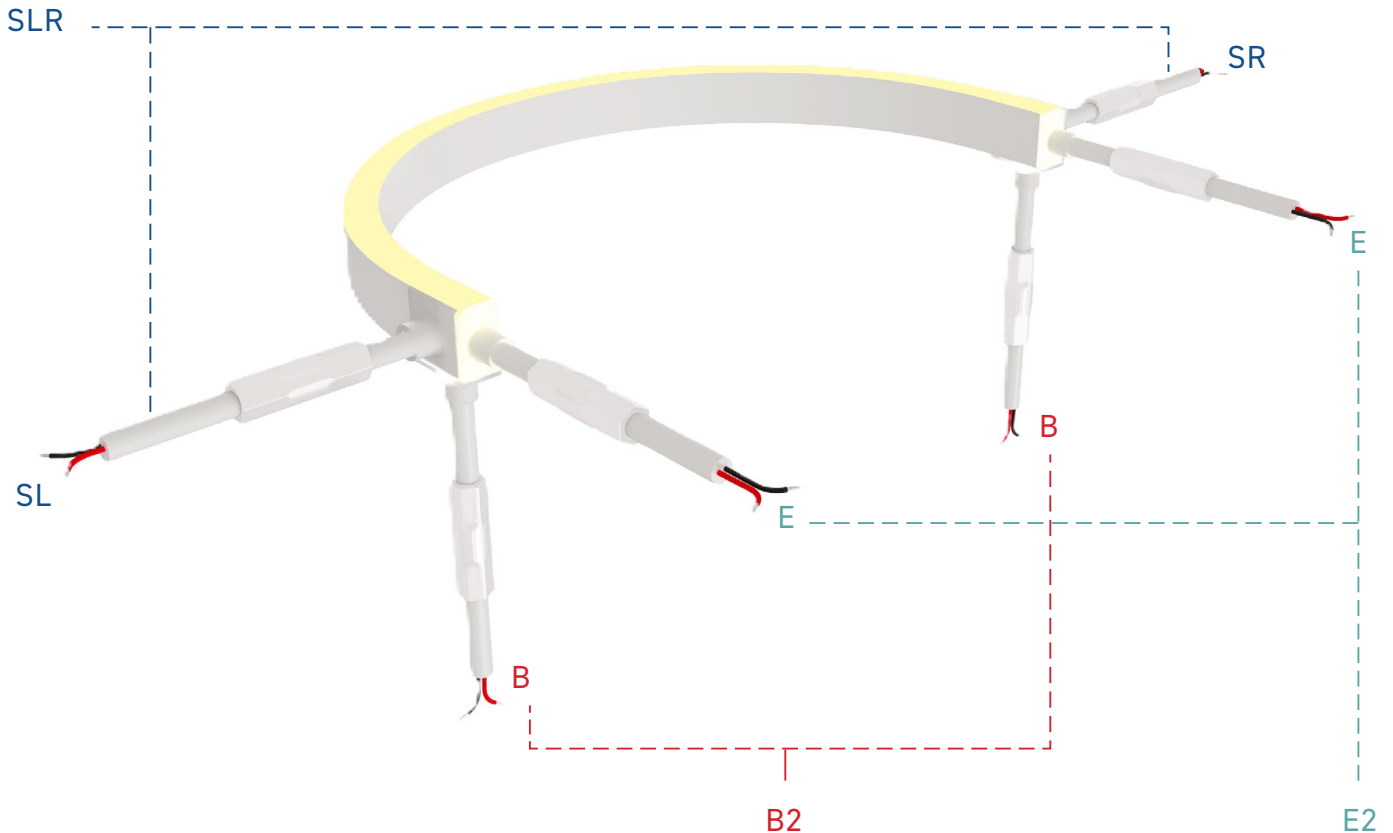

# AKWA+FLEX-50 WIRING DIAGRAMS

## TUNABLE WHITE

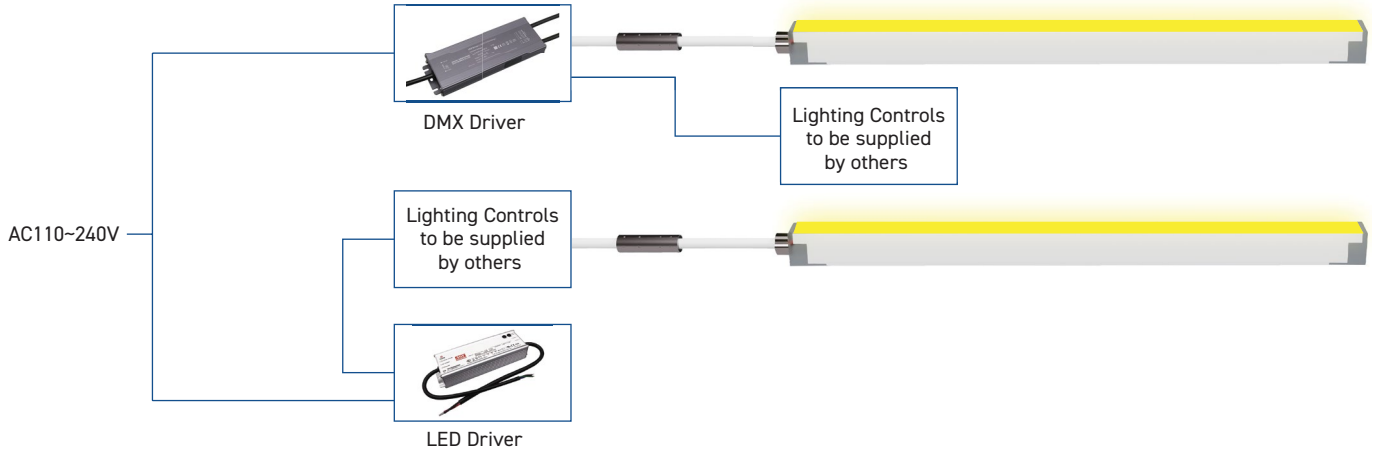

## MOUNTING OPTIONS

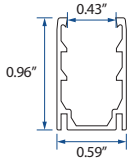

A - AF50S01

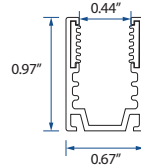

B - AF50S04

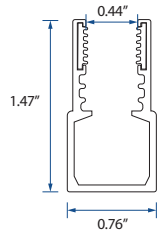
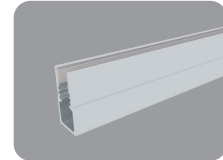

C - AF50H05

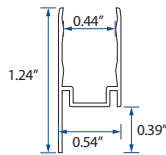
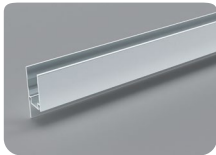

D - AF50V01

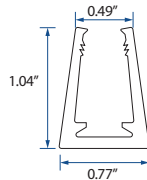

E - AFPC50S01-T

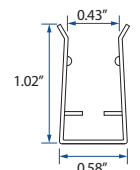
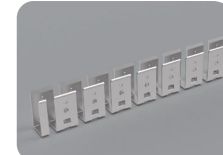

F - AFSSC50FLX

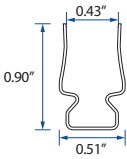
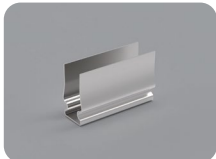

G - AFSSC50S01-05

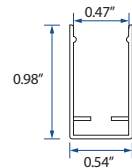
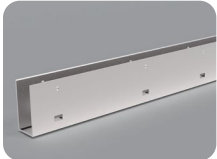

H - AFSSC50S02-100

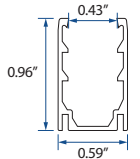

I - AF50S01FLX

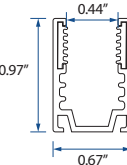
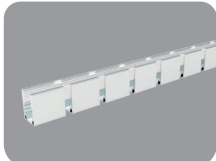

J - AF50S04FLX

## ACCESSORIES

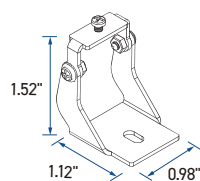

Adjustable Bracket - A - AF50ADJ