

AKWAVFLEX-40

SPECIFICATION SHEET

Project Name: _____

Specifier: _____

Location: _____

Product Code: _____



Material:
Silicon



Impact Rating:
IK08



Weatherproof Rating:
IP68
Wet Location



Operating Temp:
-40°F - 131°F



Bending Direction:
Vertical



UL Listed



Beam Angle:
120°



Dimmable:
0-10V, DMX, Triac



Bend Radius:
>3.15"



CRI:
>80+



DIRECT	AKWA Silicone Resin Encapsulation Vertical Bend
Input Voltage	24V
Power Consumption	3.05W/ft
Standard CRI	>80
LEDs per foot/m	44 144
Incremental length in/mm	3.27" 83.3mm

Color Temperature [K]	Lumen Output [lm/ft]
2700K	131lm
3000K	131lm
3500K	137lm
4000K	137lm

Other LED Options	static colors, RGB
Control	0-10V · DMX
Optics	opal symmetrical 120° diffuser
Finish	white
Mounting	surface · wall
Accessories	mounting channel / profile

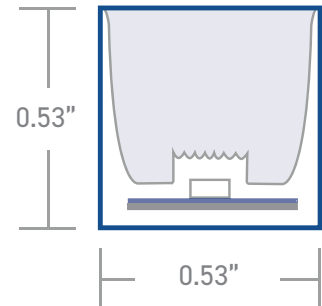

Due to tolerances of the production process and the electrical components, values for light output, color temperature and electrical power can vary up to 10%.

How to specify KLIK USA AKWA Flex 40. **Example of specification:** AF4030KS XX.X BCA

Fixture Type	Color Temp [K]	Mounting	Nominal Length [feet] with one feed ^{1,2}	Power Entry Location ³	Nominal Power Entry Termination	Mounting Profiles & Brackets	Control
AF40	27K 2700K 30K 3000K 35K 3500K 40K 4000K R Red G Green B Blue RGB RGB	S Surface W Wall-mount	XX.X Specify run Length [ft]	B Back one end B2 Back each end EP End Plate one end EP2 End Plate each end S Side S2 Side each end	- Bare cable anti-wick device [Std] M Male IP68 Connector F Female IP68 Connector	A AF40S01 B AF40S02 C AF40S02FLX D AF40S03 E AFSSC40S01-100	- 0-10V Dim [Std] DMX1 DMX 1 Ch DMX4 DMX RGBW

1. Specify length of run

2. Max run length per power entry feed is 32.8' [10m], 65.61' [20m] for 2 x feeds [one at each end]

3. B2, EP2 & S2 only required if exceeding the maximum single power entry feed as indicated above

AKWAVFLEX-40

POWER ENTRY LOCATIONS

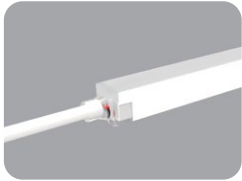

Power Entry - End

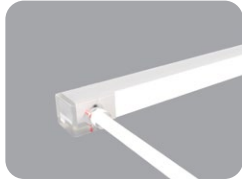

Power Entry - Side



Power Entry - Back

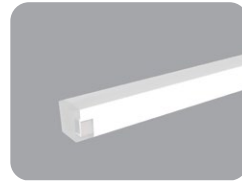

End Plate

MOUNTING OPTIONS

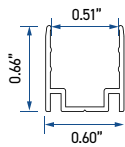

A - AF40S01

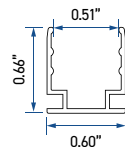

B - AF40S02

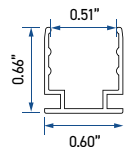
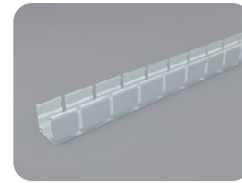

C - AF40S02FLX

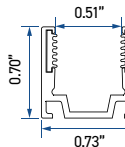
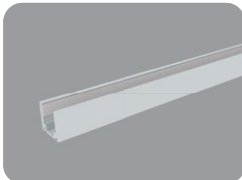

D - AF40S03

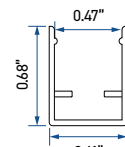

E - AFSSC40S01-100

AKWAV FLEX-40 WIRING DIAGRAMS

MONO COLOR

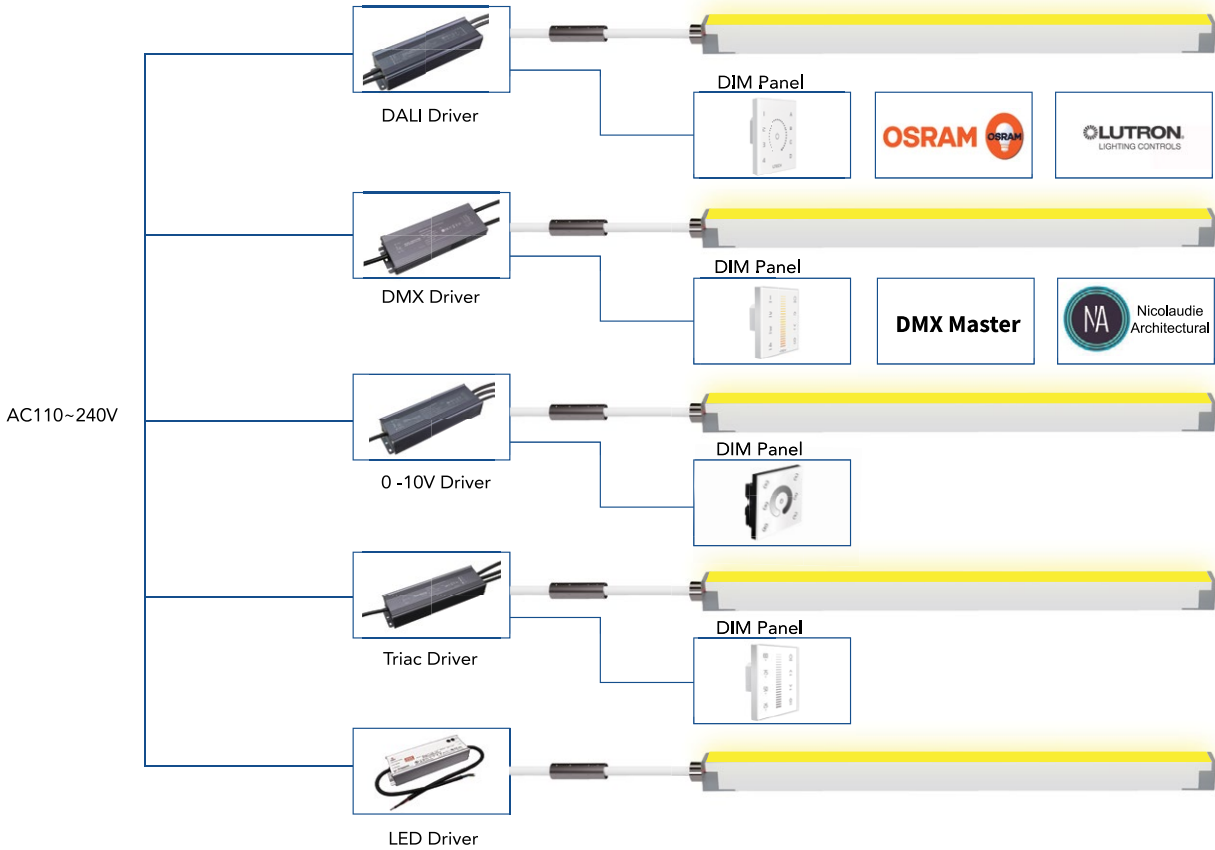

RGB

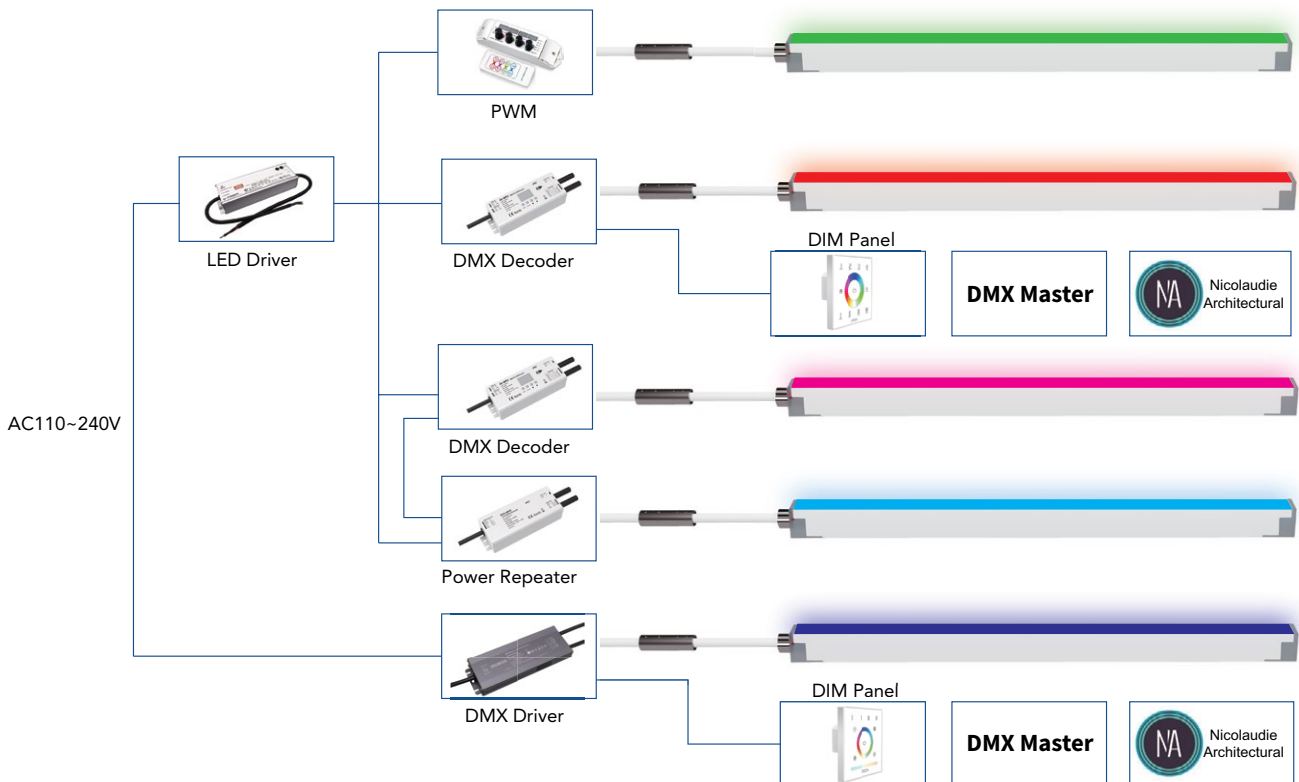

AKWAV FLEX-40 WIRING DIAGRAMS

RGBW [3K]

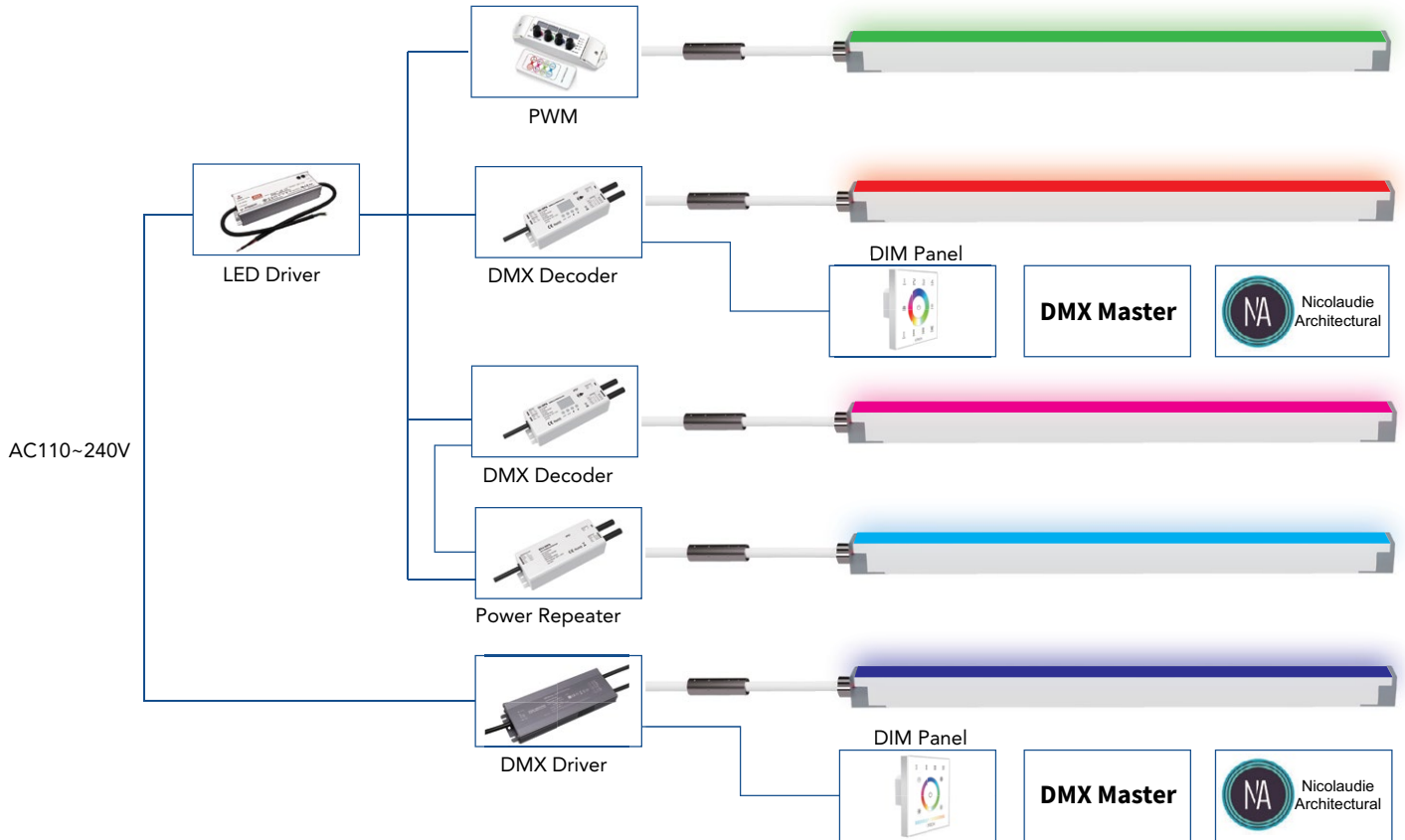

DMX DYNAMIC

