

Project Name: Location:

Specifier: Rep Agency:

Fixture Type: Product Code:

KLIK LEDpod™ 40 Patented

DESCRIPTION

Discrete, seamless point source LED fixture for use in all code-compliant handrail, especially curving ramps and helical stairs as well as long runs on bridges and pedestrian paths. Asymmetric optic allows mounting at rail nadir, eliminating uncomfortable glare issues. Typical spacing between LEDpods on stairs is 24", and on level runs is 48".

HOUSING

Aluminum body has a fine 25-micron finish and is then hard-coat anodized, thus preventing galvanic corrosion. Silicone gasket seals the installation from water ingress and provides added means of electrical isolation to minimize potential for galvanic reaction.

MOUNTING

Patented attachment method offers unparalleled security and ease of mounting. Requires only a simple drilled hole in railing material. All conductors remain internal to railing to provide secure and safe wiring. IK10 Impact rating ensures vandal resistance.

- Tube Size: \varnothing 1.5" - 1.75", Max. wall .2"
Other sizes available upon request.
- Cut Out: 25mm
 - Must use a 25mm annular cutter [NOT a 1" cutter].

ELECTRICAL/LED DRIVER

- Input Voltage: 24 VDC
- Driver: Must use class 2 driver
 - Primary Driver: 110 - 277 VAC UL Listed Constant Voltage
 - Secondary Driver: 350 - 700mA Constant Current (provided with fixture)
- Control: 0-10V, DALI, DMX
 - DMX control for dimming only, not for individually addressed LEDpod
- Enclosure: Minimum NEMA2 for indoor, NEMA 3R for outdoor
- Wire connectors provided; factory pre-wire available, consult factory

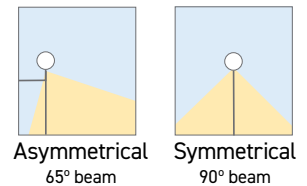
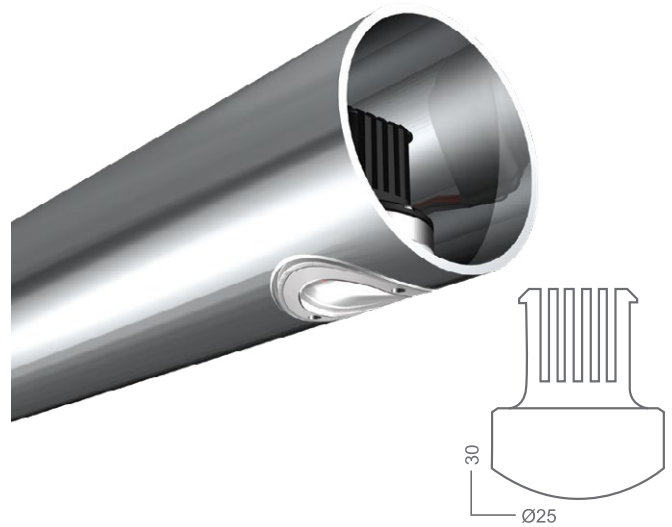

ETL listed
UL 1598/CSA 22.2; CE



LED Operating Temp:
-40°F - 160°F



Weatherproof Rating:
IP66
Wet location rated



3G Vibration
per MIL-STD-810G



Impact resistance:
IK10



Wildlife friendly



International Dark Sky Association Certified Amber \leq 3000K

* All IP rated luminaires tested to AS60529-2004 Degrees of protection provided by enclosures (IP Code)

KLIK LEDpod™ 40 Patented

SPECIFICATION TABLE		Follow the steps to specify your fixture. Enter Product Code in field at top of page. Example: LP4030KA40						
Fixture Type	Color Temp [K]	Distribution	Rail Wall Thickness¹	Lens Options	Security	Output (W)	Anodized Bezel Options	Control
LP40	22K 2200K	A Asymmetric	1512 1.5" x 11ga	- Clear lens [Std]	- Tamper resistant [Std]	- 500mA 2W [Std]	- Marine grade anodized [Std]	- 0-10V Dim
	27K 2700K	S Symmetric	1513 1.5" x 1/8 Wall	FR Opaque frost	TP Tamperproof	350 350mA 1.5W	BRS Antique Brass	DMX1 DMX 1 Ch
	30K 3000K		1506 1.5" 16ga	OT Optical filter	[Requires the KLIK tool]	700 700mA 2.6W	BLK Black Anodized	PH [Phase dim]
	35K 3500K		05 1 1/4 SC5 Pipe				BZ Bronze	
	40K 4000K		10 1 1/4 SC10 Pipe				ANT Dark Antique	
	AMB FWC Amber		40 1 1/4 SC40 Pipe				GLD Rose Gold	
	PCA Phos-converted Amber		80 1 1/4 SC80 Pipe					
	R Red		CUST Non-stock					
	G Green							
	B Blue							

¹Clips for Bronze railing requires a special alloy | consult factory

LED PERFORMANCE		Outputs based on 3000K			SYMMETRICAL	ASYMMETRICAL
LED:	Cree XT-E	W	mA	V	Delivered Lumens	
CCT:	Refer to the specification table for details	1.5	350	3	115	81
CRI:	80-85	2	500	3	165	123
Life:	80% at 50k hrs and 85°C	2.6	700	3	214	160
Binning:	3 MacAdam Steps					
Warranty:	5 Year Warranty					

REMOTE MOUNTING DISTANCE CHART				
24 VDC 100W Driver	Approx. distance from driver to first LED at 32 fixtures			
Wire Size	10 AWG	12 AWG	14 AWG	16 AWG
Distance	525'	328'	213'	131'

PRIMARY DRIVER			
Power Supply 24V DC [PSU]	Secondary LED Driver	Spacing	Maximum KLIK LEDpods™*
110 - 277 Primary Voltage	700mA	24"	30
Remotely Mounted	500mA	24"	37
Dimming Control	350mA	24"	50
10" x 1.5" x 2"			

Increased spacing or higher output LEDpods reduces the number of PODs per circuit and the remote distance.

*Based on 16 AWG between LEDpods ≤ 50' remote distance

REMOTE POWER SUPPLIES [PSUs]	
LP040WPRITRNDIMIP	Class 2; 40W; 0-10 Dim Constant Voltage Remote PSU [IP67 (Temp Submersion) Rated; -40°C ~ +85°C]
LP096WPRITRNDIM	Class 2, 96W, 0-10 Dim Constant Voltage Remote PSU [IP67 (Temp Submersion) Rated; -40°C ~ +80°C]
LP100WPRITRNDIM	Class 2, 96W, 0-10 Dim Constant Voltage Remote PSU [IP64 (Damp Location) Rated; -25°C ~ +40°C]
LPQZ96WUNV24VPH010	Class 2, 96W, Phase or 0-10 Dim Constant Voltage Remote PSU [IP66 (Wet Location) Rated; -40°C ~ +60°C]
LPQZ96WUNV24VDMX1CH	Class 2, 96W, 8-Bit DMX Dim Constant Voltage Remote PSU [IP66 (Wet Location) Rated; -40°C ~ +60°C]

REMOTE NEMA ENCLOSURES	
LPNEMA2RENCL	NEMA2 INDOOR enclosure for LP100WPRITRNDIM, 12 x 3.3 x 2
LPNEMA3RENCLJR	NEMA3R Drip Proof Enclosure, 4 x 4 x 12 [IP24 Equivalent]
LPNEMA3RXENCLSS	NEMA3 304 Lockable Stainless Steel Drip Proof Enclosure 4 x 4 x 12 [IP24 Equivalent]
LPNEMA4ENCLJR	NEMA4 Watertight Enclosure, 6 x 4 x 12 [IP66 Equivalent]; NEMA4X
LPNEMA4XENCLSSJR	NEMA4 304 Lockable Stainless Steel Watertight Enclosure 6 x 4 x 12 [IP66 Equivalent] NEMA4X
LPNEMA6PTR0	NEMA6 Watertight Enclosure Wiring Trough, 2 x 3 x 14 [IP68 Equivalent]

Additional driver & enclosure configurations available, including IP68 options
 Please note the KLIK UL Listing requires purchase of a remote driver and enclosure.

KLIK LEDpod™ 40 Patented SINGLE SIDED

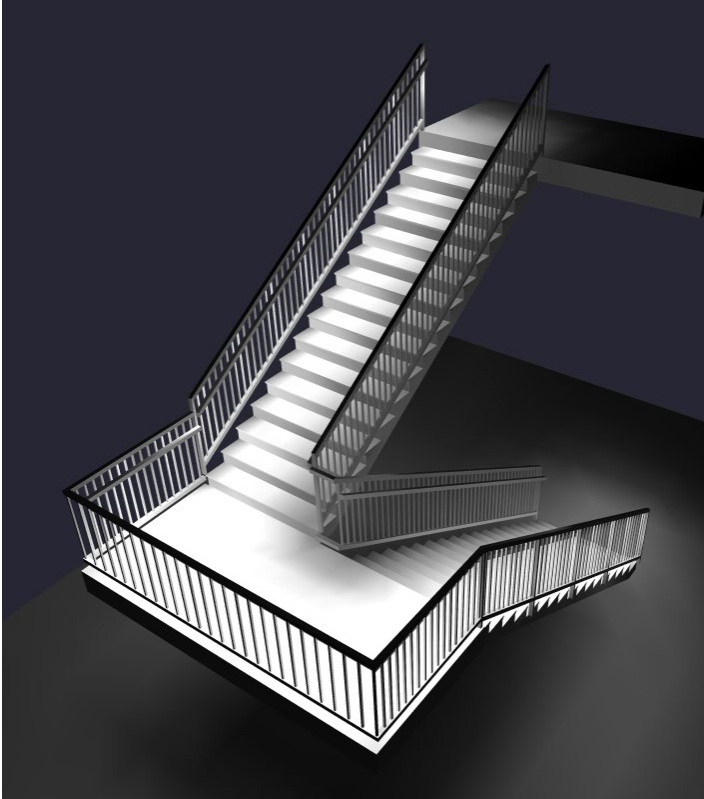

QTY	LABEL	ARRANGEMENT	LUMENS	LLF	DESCRIPTION
26	A	Single	130	0.900	LPOD40-3K-500mA-2.0W-Asym Clear Lens

Landing readings taken on landing. Stair readings taken on stair. (Design based on 2' centers.)

LABEL	UNITS	AVG	MAX	MIN	AVG/MIN	MAX/MIN
Landing	Fc	13.73	22.2	3.0	4.58	7.40

STAIRS	UNITS	AVG	MAX	MIN	AVG/MIN	MAX/MIN
1-1	Fc	3.99	5.9	0.9	4.43	6.56
1-10	Fc	6.83	12.0	0.9	7.59	13.33
1-11	Fc	6.68	11.3	0.9	7.42	12.56
1-12	Fc	6.86	12.1	0.9	7.62	13.44
1-13	Fc	6.50	11.1	0.8	8.13	13.88
1-14	Fc	6.84	12.1	0.8	8.55	15.13
1-15	Fc	6.43	11.2	0.8	8.04	14.00
1-16	Fc	6.88	12.4	0.6	11.47	20.67
1-17	Fc	6.14	10.9	0.6	10.23	18.17
1-2	Fc	6.11	9.9	0.9	6.79	11.00
1-3	Fc	7.00	12.2	0.9	7.78	13.56
1-4	Fc	6.64	11.4	1.0	6.64	11.40
1-5	Fc	7.04	12.2	0.9	7.82	13.56
1-6	Fc	6.73	11.6	1.0	6.73	11.60
1-7	Fc	6.96	11.9	0.9	7.73	13.22
1-8	Fc	6.80	11.9	0.9	7.56	13.22
1-9	Fc	6.86	11.7	0.9	7.62	13.00
2-1	Fc	8.36	14.5	2.1	3.98	6.90
2-10	Fc	7.33	12.6	1.9	3.86	6.63
2-11	Fc	7.60	13.5	1.7	4.47	7.94
2-12	Fc	7.28	12.7	2.0	3.64	6.35
2-13	Fc	7.74	13.5	1.7	4.55	7.94
2-14	Fc	7.00	13.0	1.5	4.67	8.67
2-15	Fc	6.56	11.8	1.1	5.96	10.73
2-16	Fc	5.65	11.2	0.7	8.07	16.00
2-2	Fc	8.10	14.3	1.9	4.26	7.53
2-3	Fc	7.05	13.1	1.5	4.70	8.73
2-4	Fc	7.85	13.6	1.8	4.36	7.56
2-5	Fc	7.25	13.4	1.6	4.53	8.38
2-6	Fc	7.66	12.9	1.8	4.26	7.17
2-7	Fc	7.45	13.5	1.6	4.66	8.44
2-8	Fc	7.46	12.6	1.8	4.14	7.00
2-9	Fc	7.56	13.7	1.6	4.73	8.56

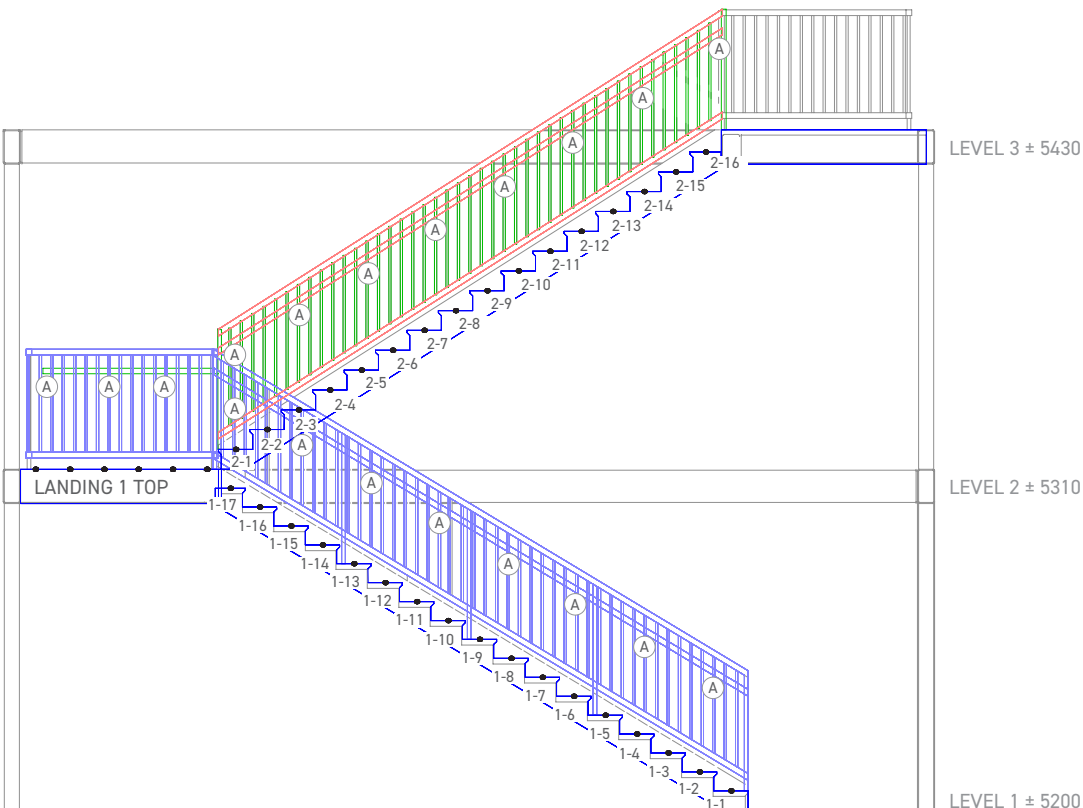

KLIK LEDpod™ 40 Patented SINGLE SIDED

LANDING 1 TOP

2	5'-11 1/4"		9.4	12.9	13.8	12.8	11.5	10.7	10.5	10.8	11.7	13.1	14.2	12.9	9.9						
			14.3	18.8	19.8	18.3	16.4	15.2	14.9	15.4	16.8	18.9	20.5	19.2	15.1						
			16.1	20.6	20.9	18.4	15.8	14.2	13.9	14.6	16.7	19.6	22.2	21.6	16.4						
			15.0	19.0	18.5	14.9	11.7	10.0	9.8	10.9	13.4	16.9	20.1	20.3	15.2						
			13.4	16.8	15.2	10.9	7.2	5.6	5.7	6.8	9.4	12.9	16.2	17.0	12.8						
			12.6	15.6	13.3	8.6	4.7	3.0	3.2	3.5	6.5	9.6	12.7	14.1	8.8						
1.8	± 26'-8"	15'-0 1/2"	STAIRS 1-17	10.2	10.9	9.9	7.3	5.1	3.4	1.7	0.6		2.1	3.2	4.9	7.5	10.2	13.2	14.5	11.3	STAIRS 2-1
			STAIRS 1-16	10.4	12.4	11.5	8.9	6.0	3.5	1.7	0.6		1.9	2.8	4.4	6.9	10.0	12.7	14.3	11.8	STAIRS 2-2
			STAIRS 1-15	10.0	11.2	10.2	7.9	5.6	3.7	2.0	0.8		1.8	2.8	4.5	6.9	9.7	12.1	13.6	11.4	STAIRS 2-3
			STAIRS 1-14	10.2	12.1	11.2	8.7	6.0	3.7	2.0	0.8		1.5	2.5	3.9	5.7	8.1	11.5	13.1	10.1	STAIRS 2-4
			STAIRS 1-13	9.7	11.1	10.2	8.2	5.9	4.0	2.1	0.8		1.6	2.5	3.8	5.8	8.7	11.8	13.4	10.4	STAIRS 2-5
			STAIRS 1-12	10.2	12.1	11.2	8.7	5.9	3.8	2.1	0.9		1.8	2.9	4.7	6.9	9.5	11.6	12.9	11.0	STAIRS 2-6
			STAIRS 1-11	9.9	11.3	10.5	8.4	6.1	4.1	2.2	0.9		1.6	2.6	3.9	6.1	9.1	12.0	13.5	10.8	STAIRS 2-7
			STAIRS 1-10	10.0	12.0	11.1	8.6	5.9	3.9	2.2	0.9		1.8	3.0	4.6	6.7	9.2	11.3	12.6	10.5	STAIRS 2-8
			STAIRS 1-9	10.2	11.7	10.8	8.7	6.3	4.1	2.2	0.9		1.6	2.6	3.9	6.4	9.2	12.1	13.7	11.0	STAIRS 2-9
			STAIRS 1-8	10.0	11.9	11.0	8.4	5.9	4.0	2.3	0.9		1.9	3.0	4.6	6.5	8.7	11.2	12.6	10.1	STAIRS 2-10
			STAIRS 1-7	10.3	11.9	11.1	8.9	6.3	4.1	2.2	0.9		1.7	2.6	4.1	6.6	9.3	12.0	13.5	11.0	STAIRS 2-11
			STAIRS 1-6	9.9	11.6	10.8	8.3	5.9	4.0	2.3	1.0		2.0	3.1	4.5	6.4	8.3	11.3	12.7	9.9	STAIRS 2-12
			STAIRS 1-5	10.4	12.2	11.3	8.9	6.3	4.1	2.2	0.9		1.7	2.7	4.4	6.8	9.6	12.0	13.5	11.2	STAIRS 2-13
			STAIRS 1-4	9.7	11.4	10.5	8.2	5.9	4.1	2.3	1.0		1.5	2.5	3.8	5.7	8.2	11.4	13.0	9.9	STAIRS 2-14
			STAIRS 1-3	10.3	12.2	11.3	8.9	6.2	4.0	2.2	0.9		1.1	1.9	3.5	5.7	8.3	10.3	11.8	9.9	STAIRS 2-15
STAIRS 1-2	8.8	9.9	9.3	7.7	5.9	4.1	2.3	0.9		0.7	1.4	2.3	4.2	6.9	9.7	11.2	8.8	STAIRS 2-16			
STAIRS 1-1	4.8	5.9	5.7	5.1	4.2	3.3	2.0	0.9													
1.2	5'-8 1/4"																				
		Stair width - 5'8"																			
1																					

KLIK LEDpod™ 40 Patented DOUBLE SIDED

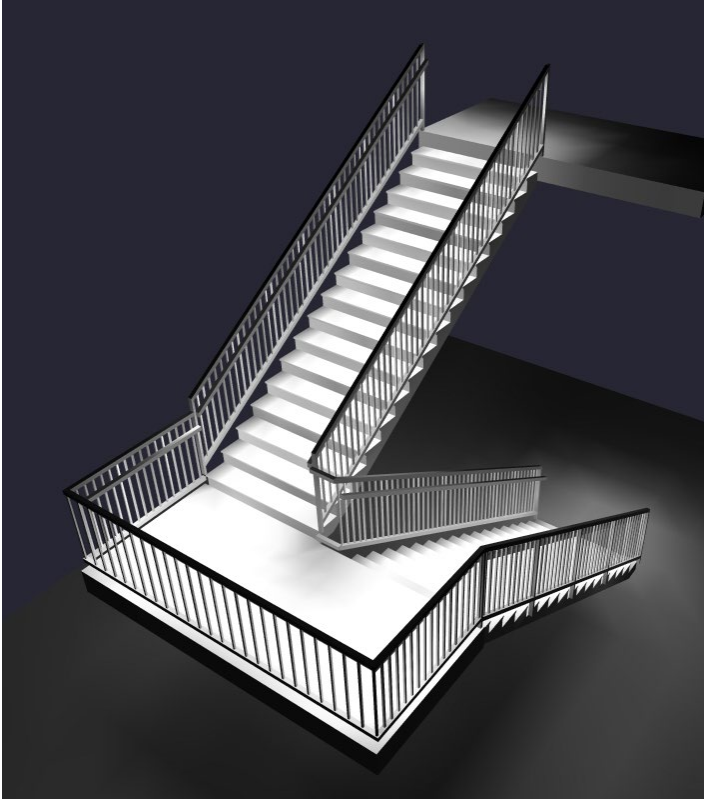

QTY	LABEL	ARRANGEMENT	LUMENS	LLF	DESCRIPTION
42	A	Single	130	0.900	LPOD40-3K-500mA-2.0W-Asym Clear Lens

Landing readings taken on landing. Stair readings taken on stair. (Design based on 2' centers.)

LABEL	UNITS	AVG	MAX	MIN	AVG/MIN	MAX/MIN
Landing	Fc	15.37	23.9	6.6	2.33	3.62

STAIRS	UNITS	AVG	MAX	MIN	AVG/MIN	MAX/MIN
1-1	Fc	7.88	9.6	3.5	2.25	2.74
1-10	Fc	13.25	15.7	6.1	2.17	2.57
1-11	Fc	13.11	15.3	6.2	2.11	2.47
1-12	Fc	13.35	15.7	6.2	2.15	2.53
1-13	Fc	12.69	14.6	6.0	2.12	2.43
1-14	Fc	13.20	15.3	6.4	2.06	2.39
1-15	Fc	12.20	14.0	5.9	2.07	2.37
1-16	Fc	12.61	14.7	6.0	2.10	2.45
1-17	Fc	10.50	12.3	5.0	2.10	2.46
1-2	Fc	11.95	13.9	5.6	2.13	2.48
1-3	Fc	13.63	15.8	6.3	2.16	2.51
1-4	Fc	12.95	15.0	6.2	2.09	2.42
1-5	Fc	13.75	15.9	6.4	2.15	2.48
1-6	Fc	13.18	15.3	6.3	2.09	2.43
1-7	Fc	13.74	15.9	6.8	2.02	2.34
1-8	Fc	13.16	15.5	6.0	2.19	2.58
1-9	Fc	13.45	15.6	6.6	2.04	2.36
2-1	Fc	14.94	17.7	10.8	1.38	1.64
2-10	Fc	14.39	15.6	11.7	1.23	1.33
2-11	Fc	15.03	16.0	12.6	1.19	1.27
2-12	Fc	14.31	15.8	11.8	1.21	1.34
2-13	Fc	15.38	16.3	12.8	1.20	1.27
2-14	Fc	13.70	15.3	11.3	1.21	1.35
2-15	Fc	13.03	13.8	11.0	1.18	1.25
2-16	Fc	11.06	12.5	9.4	1.18	1.33
2-2	Fc	15.96	17.0	13.5	1.18	1.26
2-3	Fc	13.85	15.6	11.2	1.24	1.39
2-4	Fc	15.59	16.6	13.1	1.19	1.27
2-5	Fc	14.33	15.9	11.7	1.22	1.36
2-6	Fc	15.21	16.3	12.6	1.21	1.29
2-7	Fc	14.74	16.0	12.2	1.21	1.31
2-8	Fc	14.74	15.9	12.1	1.22	1.31
2-9	Fc	14.94	16.1	12.6	1.19	1.28

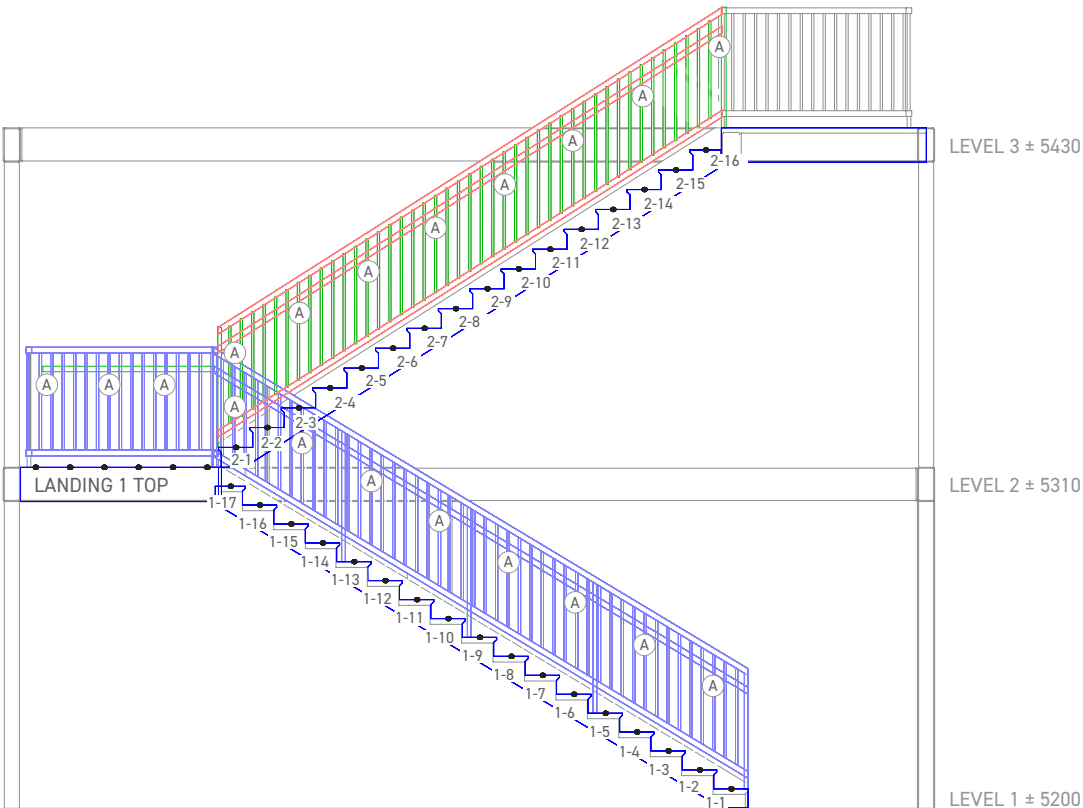

KLIK LEDpod™ 40 Patented DOUBLE SIDED

LANDING 1 TOP

2	5'-11 1/4"	9.5	12.9	13.9	12.9	11.6	10.8	10.7	11.1	12.2	13.6	14.7	13.4	10.3						
		14.3	18.9	19.9	18.5	16.6	15.4	15.2	16.0	17.7	19.9	21.4	20.0	15.7						
		16.2	20.7	21.1	18.8	16.3	14.6	14.6	16.0	18.5	21.5	23.9	22.9	17.4						
		15.2	19.3	19.1	16.4	13.5	11.4	11.4	13.6	16.6	20.0	22.8	22.4	16.9						
		13.6	17.3	16.8	14.4	12.1	9.6	8.4	10.7	14.0	17.1	19.8	19.7	15.0						
		12.9	16.3	15.6	13.5	11.7	9.4	6.6	7.1	11.4	14.1	16.3	16.8	10.4						
		1.8	± 26'-8"	15'-0 1/2"	STAIRS 1-17 SIDE 66	11.0	12.2	12.3	11.1	11.1	11.9	9.4	5.0	10.8	13.7	14.7	15.2	16.5	17.7	17.6
STAIRS 1-16 SIDE 62	11.4	14.1			14.7	14.4	14.3	14.2	11.8	6.0	13.7	16.5	16.7	16.6	16.8	17.0	16.9	13.5	STAIRS 2-2 SIDE 8	
STAIRS 1-15 SIDE 58	11.3	13.5			14.0	13.6	13.6	13.9	11.8	5.9	11.2	15.3	15.0	13.4	13.7	15.2	15.6	11.4	STAIRS 2-3 SIDE 12	
STAIRS 1-14 SIDE 54	11.6	14.5			15.1	14.9	15.1	15.3	12.7	6.4	13.1	16.3	16.4	16.5	16.6	16.5	16.2	13.1	STAIRS 2-4 SIDE 16	
STAIRS 1-13 SIDE 50	11.2	13.8			14.6	14.5	14.6	14.6	12.2	6.0	11.7	15.8	15.6	14.0	14.2	15.5	15.9	11.9	STAIRS 2-5 SIDE 20	
STAIRS 1-12 SIDE 46	11.8	14.8			15.3	15.0	15.3	15.7	12.7	6.2	12.8	15.8	16.1	16.3	16.2	16.2	15.7	12.6	STAIRS 2-6 SIDE 24	
STAIRS 1-11 SIDE 42	11.5	14.1			15.0	15.1	15.3	15.1	12.6	6.2	12.2	16.0	15.8	14.9	14.9	15.7	16.0	12.4	STAIRS 2-7 SIDE 28	
STAIRS 1-10 SIDE 38	11.8	14.8			15.3	14.8	15.0	15.7	12.5	6.1	12.4	15.2	15.7	15.6	15.6	15.9	15.4	12.1	STAIRS 2-8 SIDE 32	
STAIRS 1-9 SIDE 34	11.8	14.5			15.4	15.5	15.6	15.4	12.8	6.6	12.6	16.0	15.9	15.5	15.3	15.5	16.1	12.6	STAIRS 2-9 SIDE 36	
STAIRS 1-8 SIDE 30	11.8	14.8			15.3	14.7	14.9	15.5	12.3	6.0	11.9	15.0	15.3	15.0	15.0	15.6	15.6	11.7	STAIRS 2-10 SIDE 40	
STAIRS 1-7 SIDE 26	12.0	14.8			15.6	15.8	15.9	15.8	13.2	6.8	12.8	15.8	16.0	15.7	15.6	15.8	15.9	12.6	STAIRS 2-11 SIDE 44	
STAIRS 1-6 SIDE 22	11.8	14.7			15.3	14.6	14.6	15.2	12.9	6.3	11.8	15.4	15.3	14.2	14.5	15.8	15.7	11.8	STAIRS 2-12 SIDE 48	
STAIRS 1-5 SIDE 18	12.2	15.1			15.8	15.8	15.9	15.8	13.0	6.4	13.1	16.1	16.3	16.2	16.3	16.2	16.0	12.8	STAIRS 2-13 SIDE 52	
STAIRS 1-4 SIDE 14	11.6	14.4			15.0	14.6	14.5	14.8	12.5	6.2	11.3	15.1	14.8	13.2	13.6	15.0	15.3	11.3	STAIRS 2-14 SIDE 56	
STAIRS 1-3 SIDE 10	12.1	15.1			15.6	15.6	15.7	15.8	12.8	6.3	11.3	13.6	13.6	13.7	13.8	13.7	13.5	11.0	STAIRS 2-15 SIDE 60	
STAIRS 1-2 SIDE 6	10.5	12.9			13.7	13.9	13.9	13.7	11.4	5.6	9.5	12.4	11.7	10.5	10.7	11.8	12.5	9.4	STAIRS 2-16 SIDE 64	
1.2	5'-8 1/4"																			
1																				

KLIK LEDpod™ 40 Patented

WIRING DIAGRAM Post Mounted

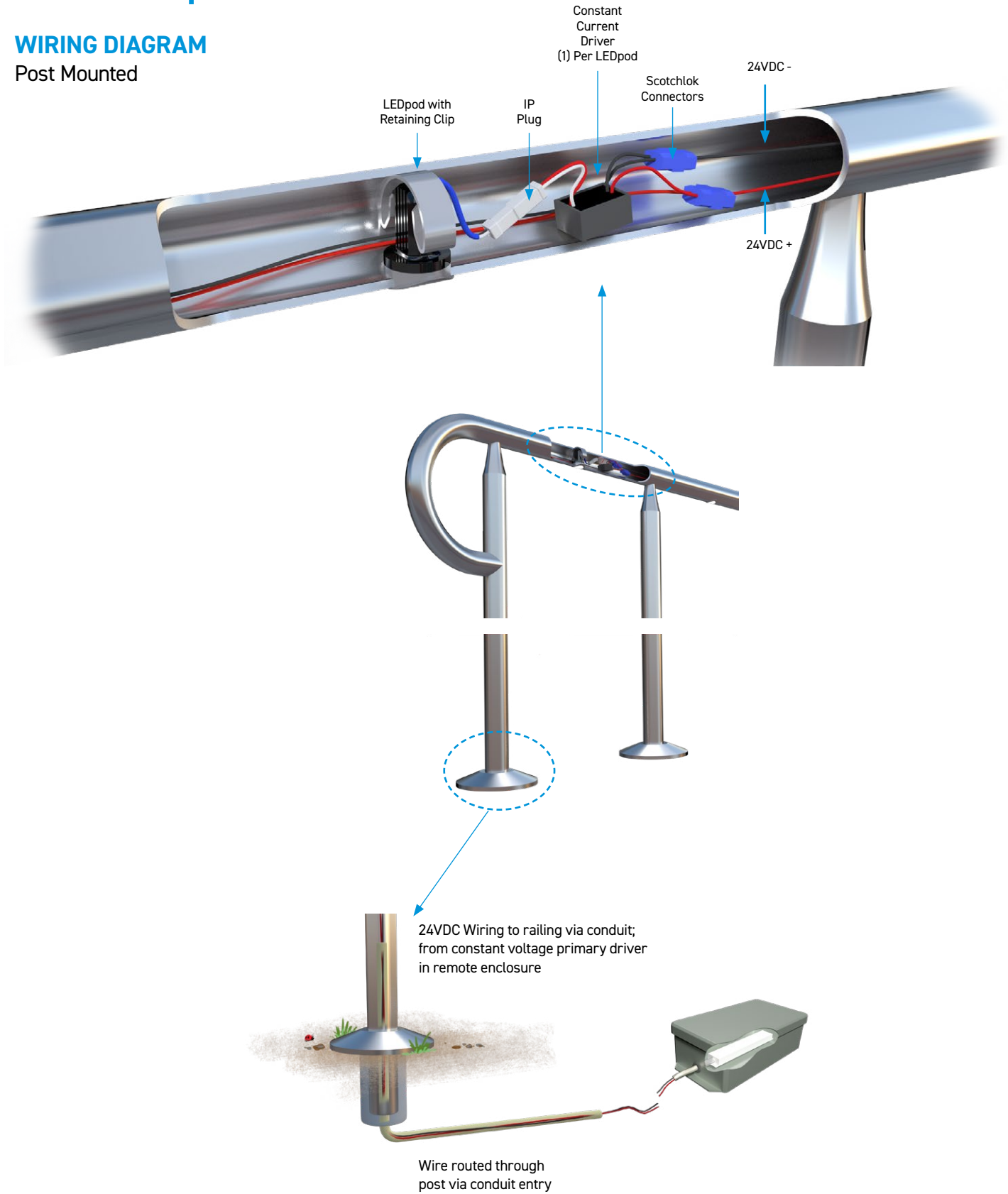

KLIK LEDpod™ 40 Patented

WIRING DIAGRAM

Wall Mounted

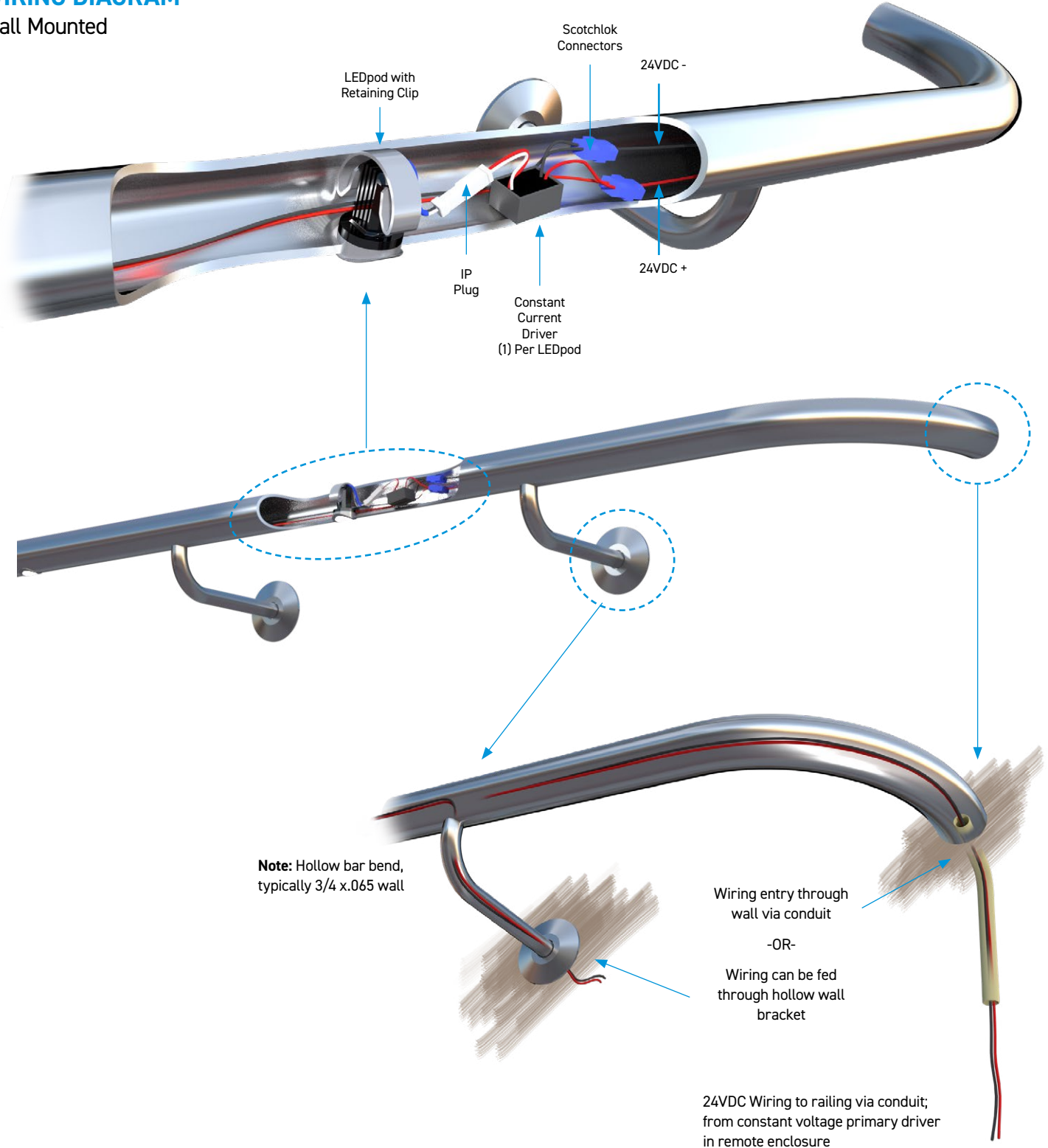

KLIK LEDpod™ 40 Patented

INSTALLATION INSTRUCTIONS Additional instructions may apply, consult factory.

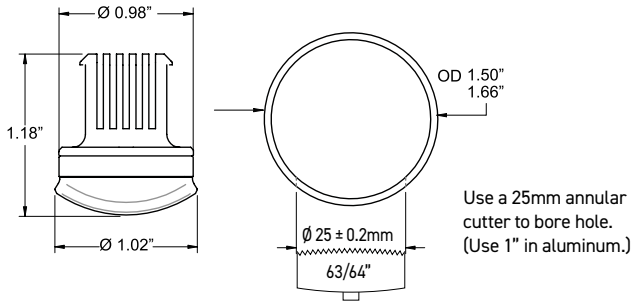

Use a 25mm annular cutter to bore hole. (Use 1" in aluminum.)

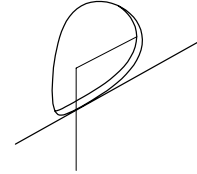

- 1 Make sure drilled holes are deburred and excess chips are removed from railing.

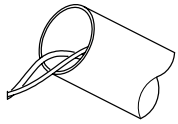

- 2 Feed through appropriate wires (14ga - 18ga).

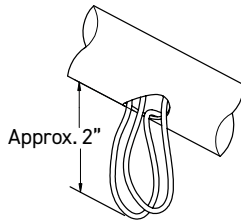

- 3 Pull a loop of wire through hole.

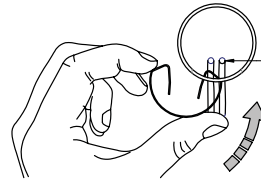

- 4 Rotate retaining clips in as shown. Avoid tangling or severing through wire.

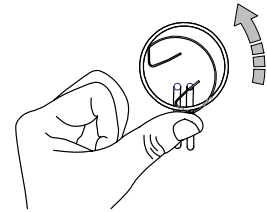

- 5 Apply pressure as shown to deform clip into place in a circular motion. Avoid damaging the surface of tube and tangling or damaging wire.

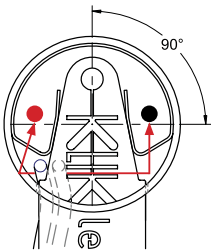

- 6 Fit clip into place until the clamping ends are equally centered over the hole. Use the tool to center the clip until equal pressure can be felt and inspect by eye.

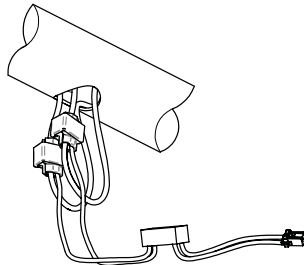

- 7 Install Scotchlok connectors to the red and black wires. Connect the corresponding color wires of the driver to the Scotchloks and assure the clip is secured.

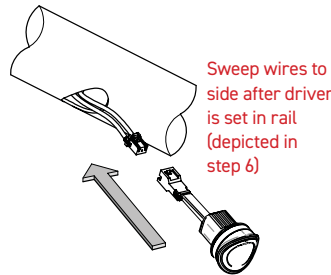

- 8 CAREFULLY feed the Scotchloks to the left of the clip and the driver to the right with the driver connector hanging out. Ensure wires are clear from where the LEDPOD is to fit. Proceed to connect the LEDPOD. Install all LEDpods to this point, then perform a circuit test to ensure all LEDpods are operational BEFORE final installation.

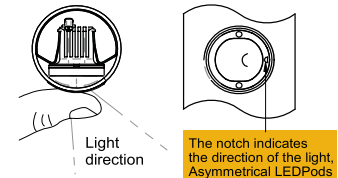

- 9 Push LEDPOD in until it snaps into place and the outer surface is flush with the outer surface of the tube. Prod the rim of the clear silicone IP Seal to provide a tighter fit.

LEDPOD REMOVAL STEPS

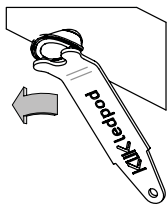

- 1 Insert removal tool into the 2mm holes in the LEDPOD. With firm pressure, rotate the LEDPod 90°.

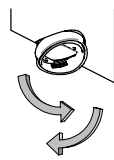

- 2 Carefully peel back the IP silicone seal one side at a time.

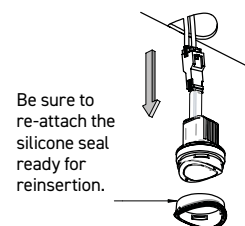

- 3 Carefully remove the LEDPOD from the clip, ensuring not to damage or disconnect wires in the process. Be sure to re-attach the silicone seal ready for reinsertion.